

Modellname:
Nazwa modelu:

ALASKA

Modellreihe:
Numer modelu:

P9 -- AS

Type:
Typ: **01**



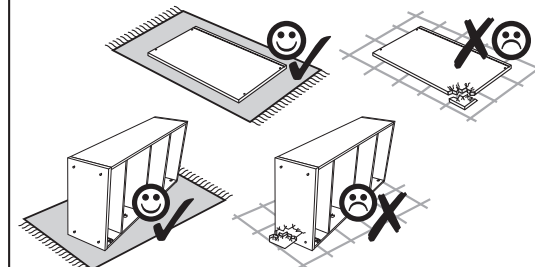
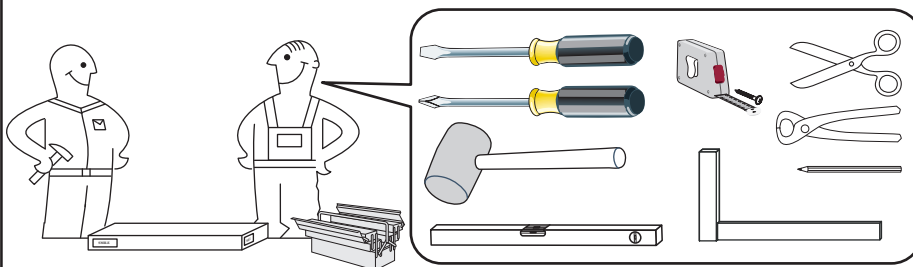
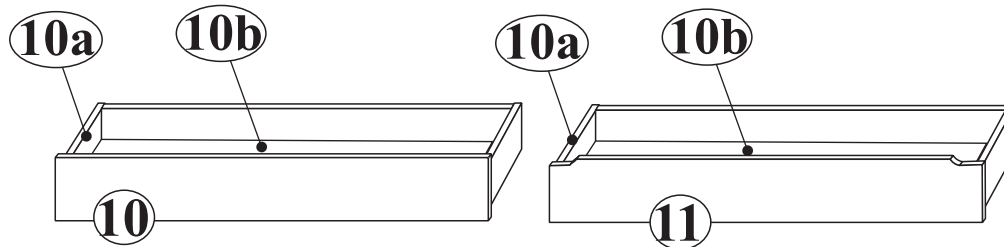
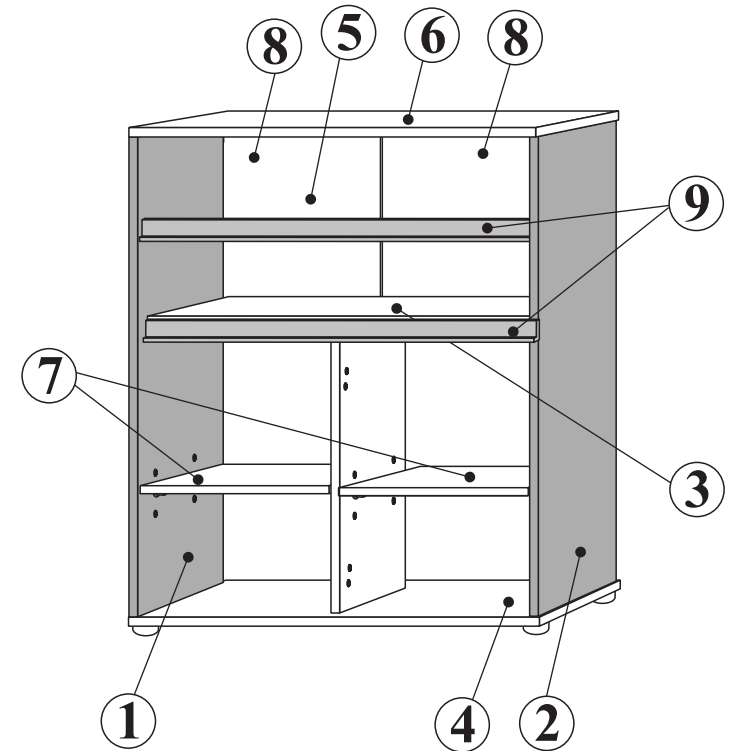
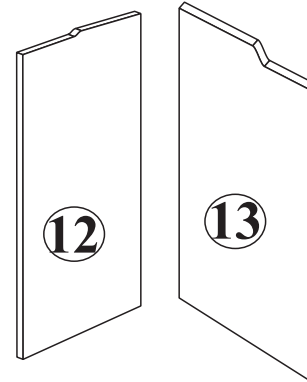
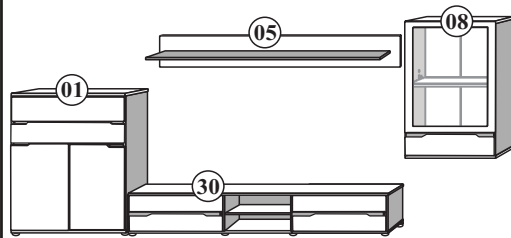
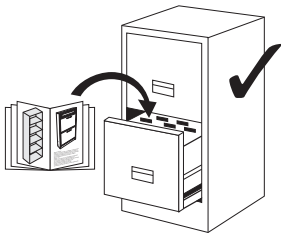
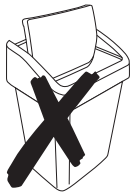

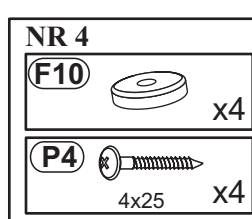
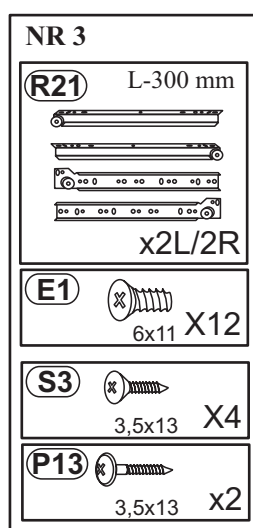
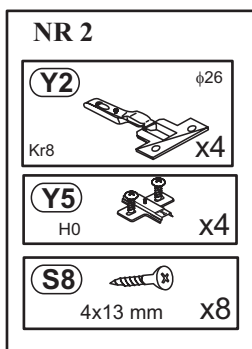
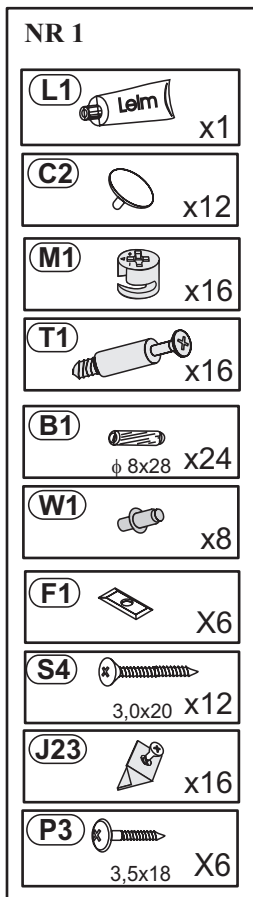
Blatt Nr
Strona **1** von: **7**
z:



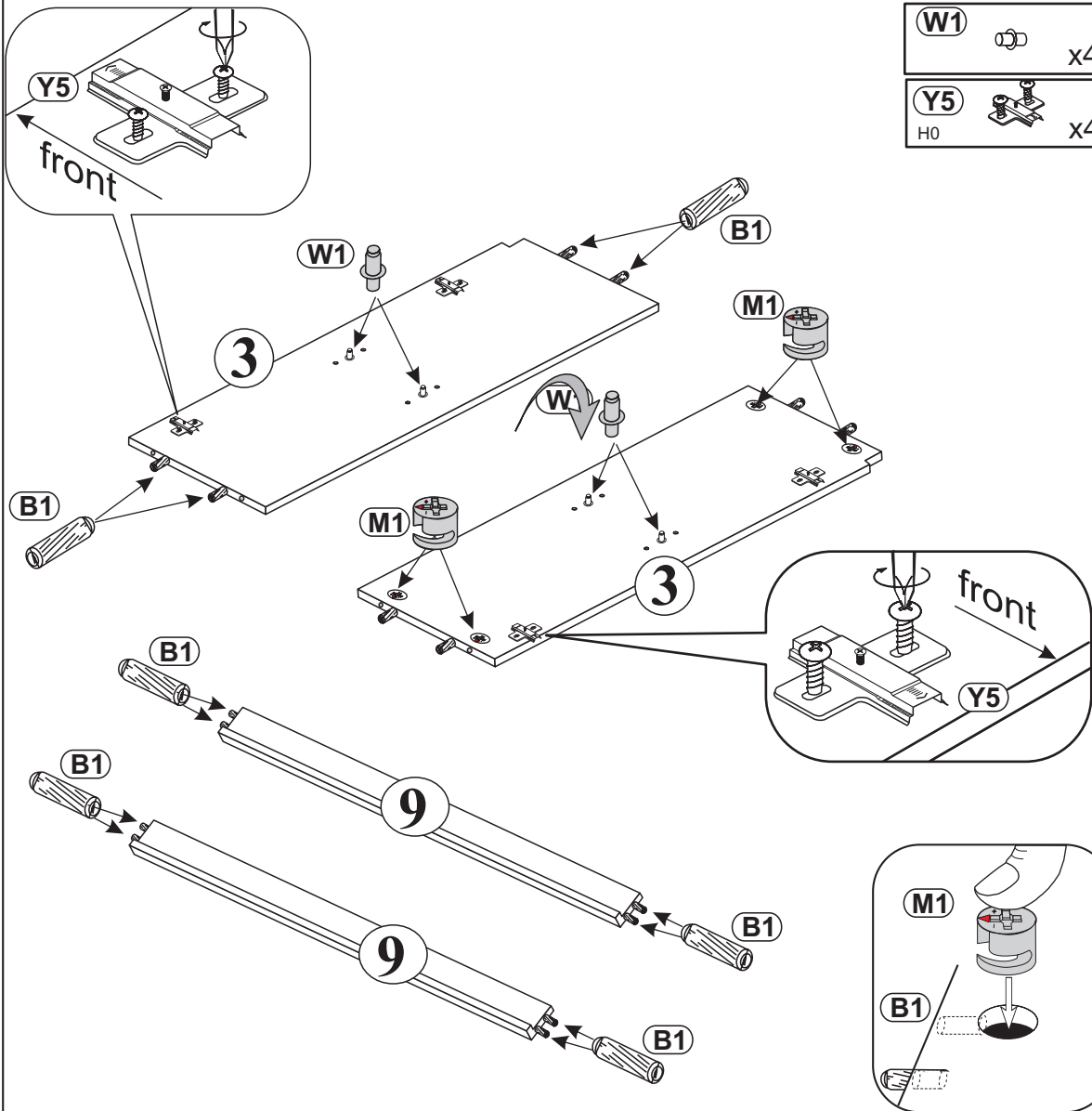



2

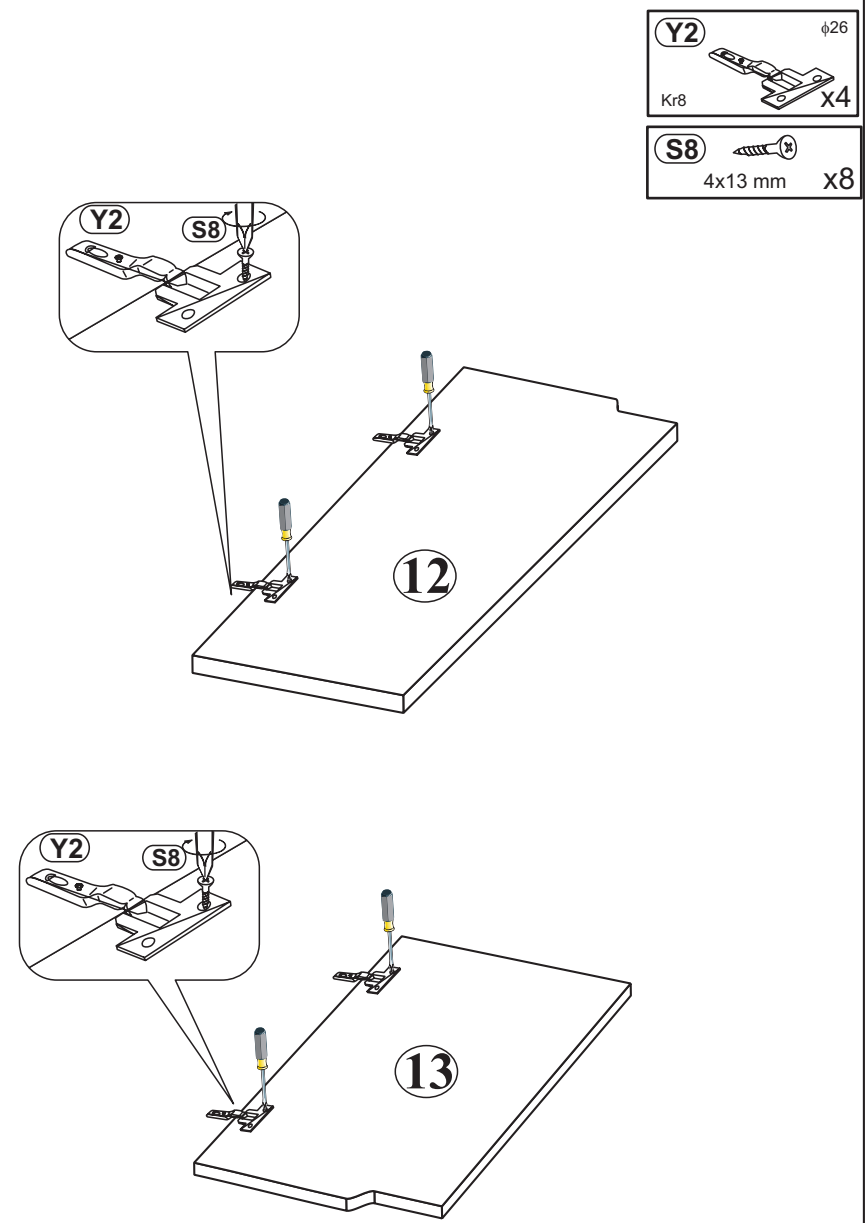

- B1**  $\phi 8 \times 28$ x16
- M1**  x4
- W1**  x4
- Y5**  H0 x4

3



- Y2**  $\phi 26$
Kr8 x4
- S8**  4x13 mm x8

4

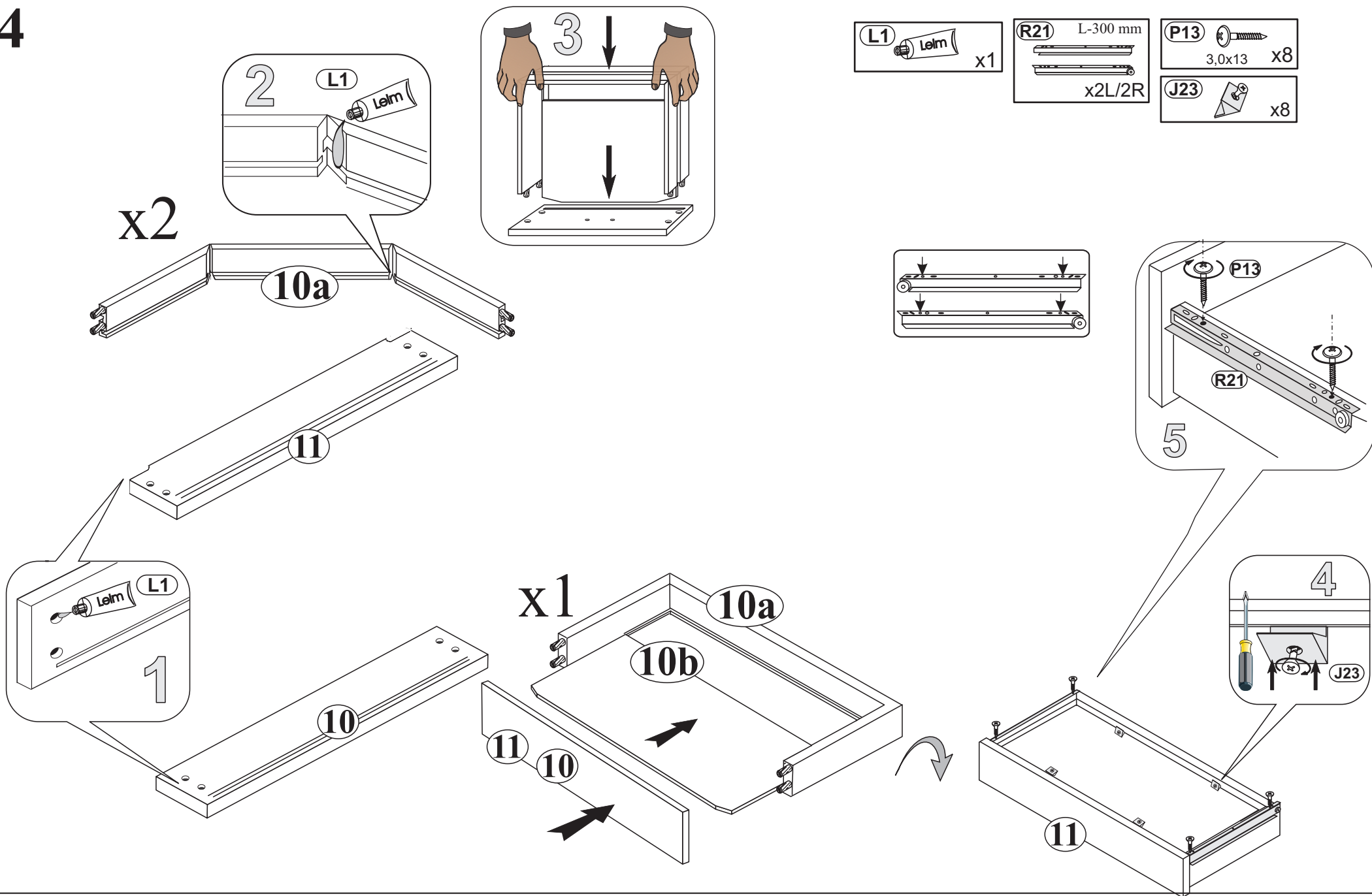

5

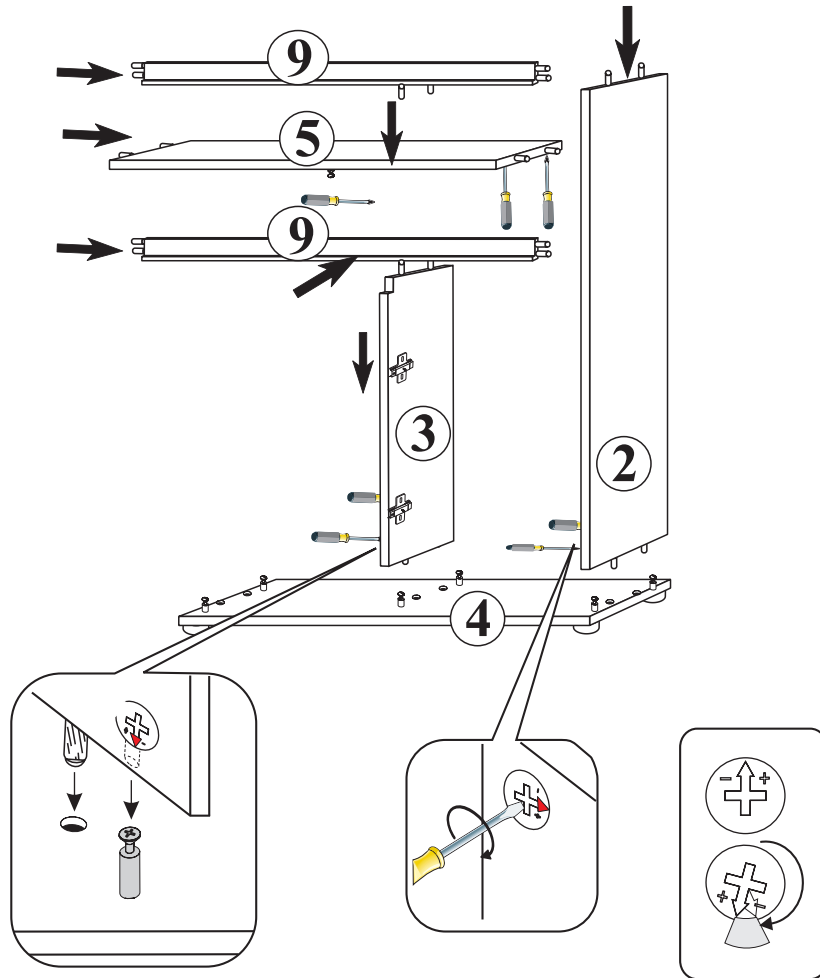

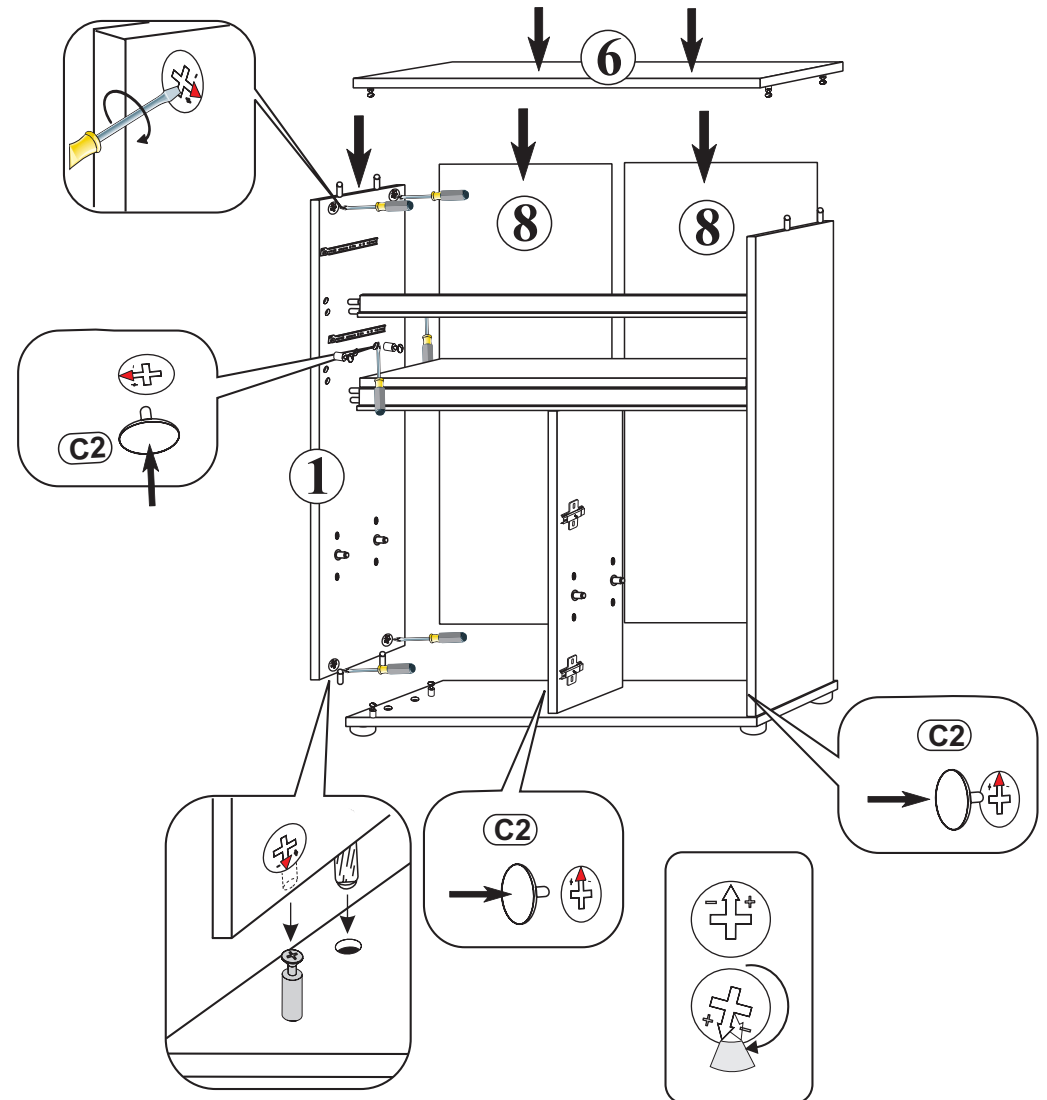

6

C2 X12



7

- F1**  X6
- S4**  3,0x20 X12
- J23**  X6

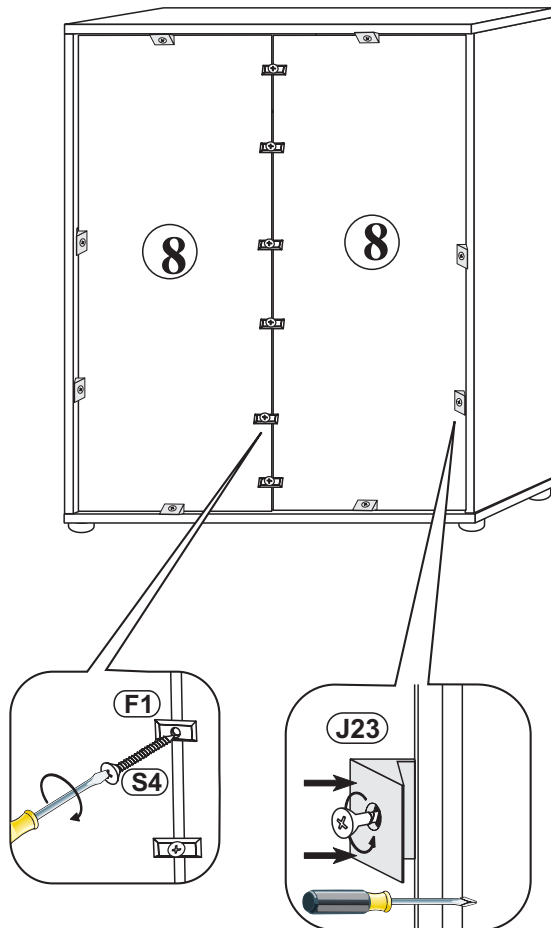

8

